

# Data Sheet



Article number: 20881M3015200MSM

Description: E+G  
Breather valve, - M30x1.5

## Measures

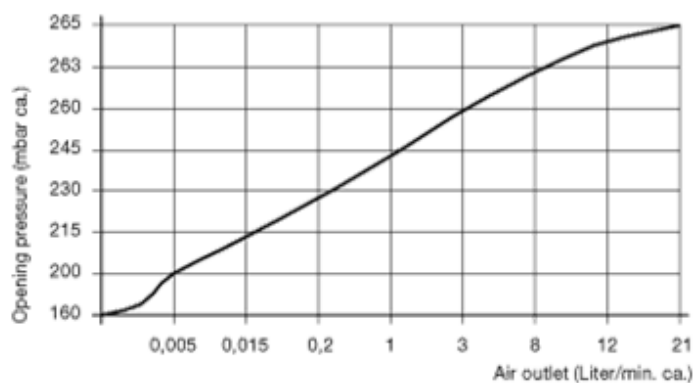
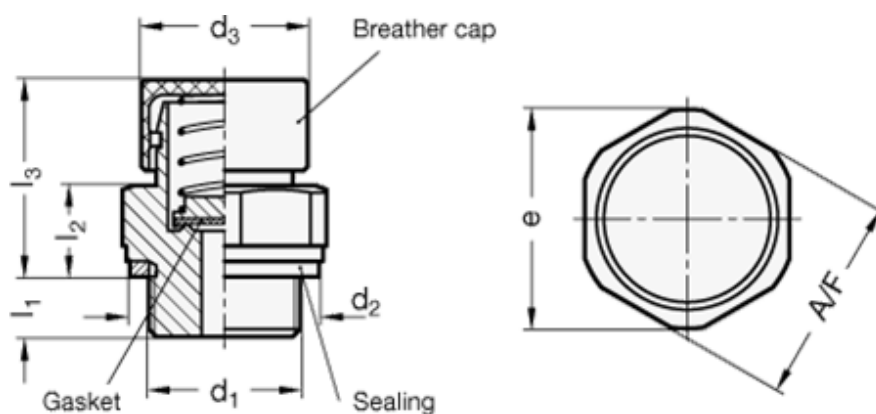

A/F	= 36
d2	= 36
d3	= 22
e	= 39
l1	= 8
l2	= 12
l3	= 27
Thread d1	= M30x1.5